

Technical information

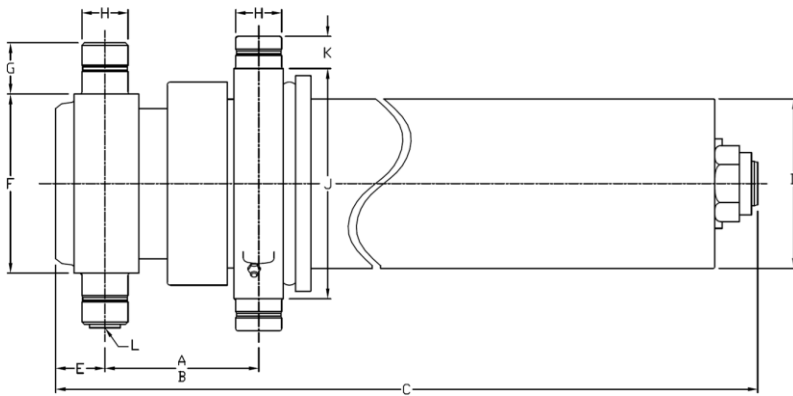

Dimensions	Imperial	Metric
A (stroke)	119,75 in	3 042 mm
B (closed)	5,25 in	133 mm
C	52,75 in	1 340 mm
D	5,56 in	141 mm
E	2,00 in	51 mm
F	5,75 in	146 mm
G	2,00 in	51 mm
H	1,88 in	48 mm
J	8,00 in	203 mm
K	1,25 in	32 mm
L	SAE-12	

Stage	Effective diameter		Effective area		Stroke	
1	4,250 in	108 mm	14,19 in ²	9 152 mm ²	39,63 in	1 006 mm
2	3,500 in	89 mm	9,62 in ²	6 207 mm ²	40,13 in	1 019 mm
3	2,750 in	70 mm	5,94 in ²	3 832 mm ²	40,00 in	1 016 mm

Specifications	Imperial	Metric
Weight without hydraulic fluid	248 lb	113 kg
Hydraulic fluid volume	5,9 gal. (US)	22 l
Maximum working pressure	2 750 psi	190 bar
Maximum pump flow	25 gpm	95 lpm
Cylinder design limit capacity*	23,4 US tons	21 228 kg

Installation components	Model	Part no.
Block	B-1875	PB3005002-A
Frame	AC-4024	PF3000012
Hinge	P-200	PP3004010

Cylinder capacity

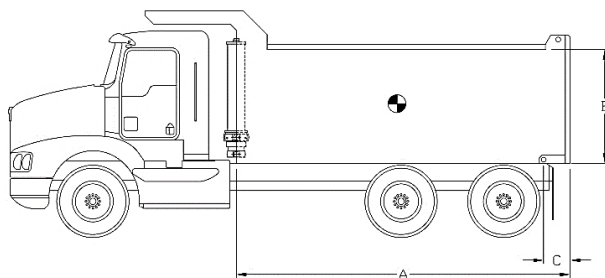

A = Body Length
B = Body height
C = Overhang

Note:	Body length	12,0 ft		13,0 ft		14,0 ft	
Cylinder capacities based on 90% of the maximum working pressure.	Overhang	0 in	6 in	6 in	12 in	12 in	18 in
	Dump angle	49,3°	51,7°	47,2°	49,3°	45,3°	47,2°
	Body height	Capacities for different box length configuration in US tons at 2000 psi (at 2750 psi)					
For reference only. See www.mailhotindustries.com	36 in	14,3 (19,7)	15,6 (21,5)	14,6 (20,1)	15,9 (21,9)	15,0 (20,6)	16,2 (22,3)
	48 in	15,3 (21,0)	16,9 (23,2)	15,6 (21,4)	17,1 (23,5)	15,8 (21,8)	17,4 (23,9)
	60 in	16,4 (22,5)	18,3 (25,2)	16,6 (22,8)	18,5 (25,4)	16,8 (23,1)	18,7 (25,7)

* See product manual

Subject to change without notice, all rights reserved.

REV 0C

Item	Part no.	Description
1	ROV051036-A	BASE TUBE Ø5.06
2	RMG042258-A	SECTION Ø4-1/4
3	RMG035257-A	SECTION Ø3-1/2
4	RNV027073-A	LAST SECTION Ø2-3/4
7	RK056168-A	COVER TUBE ASSEMBLED
8	RFG046031	END CAP Ø4-5/8
9	RFG046032	END CAP Ø4-5/8

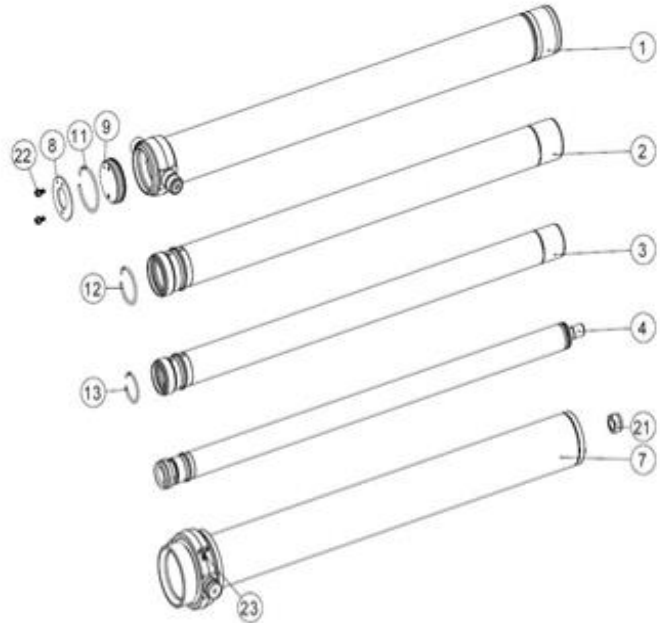

Snap ring kit Part no. : XB19G0423

Item	Description
11	SNAP RING Ø4-5/8
12	SNAP RING Ø3-3/4
13	SNAP RING Ø3

Hardware kit Part no. : ZX02G0423

Item	Description
21	STOVER NUT Ø1-1/4-12 NF GRADE C
22	SERRATED FLANGE HHS GRADE 5 Ø3/8-16 NC X 3/4 LG
23	GREASE FITTING STRAIGHT 1/8 NPT

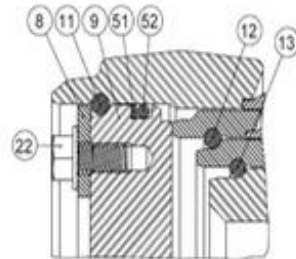

Seal kit Part no. : UI47G0423

Item	Description
31	U-CUP DZ Ø4-5/8 X Ø4-1/4 X 3/8
32	U-CUP DZ Ø3-7/8 X Ø3-1/2 X 3/8
33	U-CUP DZ Ø3-1/8 X Ø2-3/4 X 3/8
41	WIPER DT Ø4-1/4
42	WIPER DT Ø3-1/2
43	WIPER DT Ø2-3/4
51	BACK-UP RING Ø4-5/8 X Ø4-1/4
52	O-RING Ø4-5/8 X Ø4-1/4

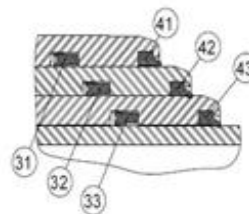

* See product manual

Subject to change without notice, all rights reserved.

REV 0C